

# TOSO

---

## Pleated Blind

---

# Shiori 25 Cord Single/Drum Single

---

No.P-08091202

---

## Instruction Manual

Thank you for purchasing TOSO products. To ensure safe use of this product, please read the following thoroughly and keep this manual stored.

### Guide for Distributors and Installation Contractors

This manual contains information for a user to safely operate this product.  
Please provide this manual to a customer.

## INDEX

■ Caution .....	2
■ Product View and Part Names .....	4
■ Installation and Detaching.....	5
■ Operation Methods .....	7
■ Maintenance Sticker.....	9
■ Replacement screens .....	9
■ Troubleshooting.....	10
■ Cleaning .....	11

## CAUTION

\* This manual contains cautions and instructions for safe use of the product. Please read it carefully before using to ensure appropriate use.

● This document illustrates the dangers of using this product without taking necessary precautions. Please refer to the symbols below for different types of safety points.

 **Warning** Illustrates that if this product is misused, there are dangers of serious injuries or possible fatal accidents.

 **Caution** Illustrates that if this product is misused, there are dangers of casualties or possible physical damage of the product.



● This document illustrates safety points to be followed using the symbols below.

 Illustrates specific actions which are prohibited.



 Illustrates specific guidelines which must be followed.

■ Precautions upon installing the product (Please read before installation.)

 **Warning**

-  Screws provided are for xylem only. Do not use on materials other than xylem.
-  Check the foundation base and strength of the material before installing this product. If not installed properly to the foundation base, there are dangers of it falling.
-  Install this product as instructed with the necessary quantity of brackets. Otherwise the product may fall.





 **Caution**

-  This product is intended for indoor use. Please do not use it for outdoor purposes.
-  Locations subject to high temperatures and high humidity, or areas where water may leak, should be avoided.
-  Make sure to install this product horizontally.



■ Safety During Use (Please read thoroughly)

 **Warning**

-  Please keep the cord or the chain where children cannot reach.
-  Please avoid actions which may result in the cord or the chain entangling the body or becoming hooked onto something. This may cause an accident.
-  When not in use, please take the cord and put away the handling cord by wrapping it around the safety hook.
-  Please do not hang from or pull on this product. This may damage the product or cause it to fall down.



Japan Blind Industry Association

-  Please do not operate the product with sudden or forceful motion. This may damage the product or cause it to fall down.



 **Caution**

-  When there is strong wind, please either close the window or have the screen completely opened up.

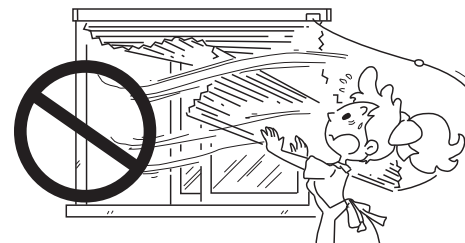

-  Please do not dismantle the mechanical assembly or lubricate the moving parts of this product. Physical damage or malfunction of the product will occur.



-  Please do not use this product around open flames.

-  Please remember to always use the operation cord when operating this product. Please do not attempt to move the screen or Bottom Rail directly.

-  Please do not place any fragile objects or objects that may interfere with operation near the screen.

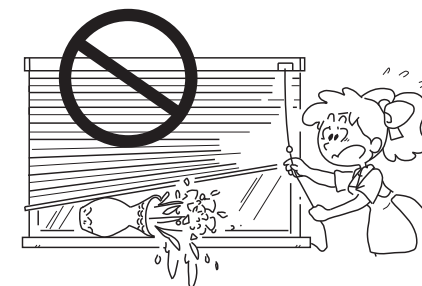

## Product View and Part Names

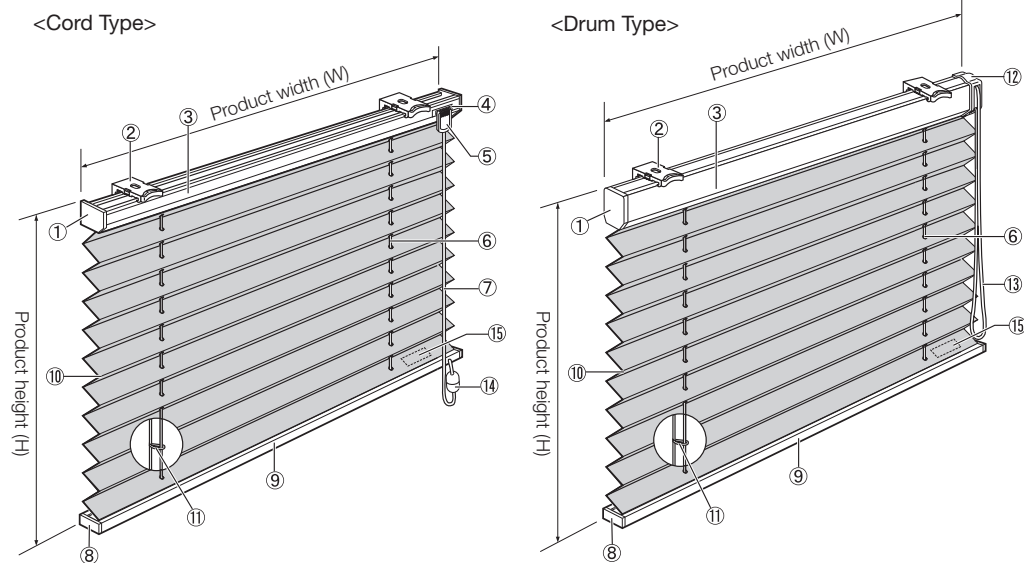

### Product Name

① Head Rail Cap	⑤ Cord Joint	⑨ Bottom Rail	⑬ Drum Operation Cord
② Bracket	⑥ Lift Cord	⑩ Screen	⑭ Safety Joint
③ Head Rail	⑦ Operation Cord	⑪ Pitch Keeper Cord	⑮ Maintenance Sticker
④ Cord Outlet	⑧ Bottom Rail Cap	⑫ Operation Pulley	

## Components Parts

Components Name	Bracket (Cord Type)	Bracket (Drum Type)	Fixing Screw (round head Ø3.5 x 20)	Safety Tassel * Drum Type only
Product Width (mm)				
-1200	2	2	2	1
1210-2000	3	3	3	
2010-	4	4	4	

## Product Weight (Product Width 2,000 mm x Product Height 2,000 mm)

Cord Type	Drum Type
2.5 kg	3.2 kg

\* Product weight varies slightly depending on the screen.

## Installation and Detaching



### Caution



Screws provided are for xylem only. Do not use on materials other than xylem.

## Installation Method

### <Front Attachment>

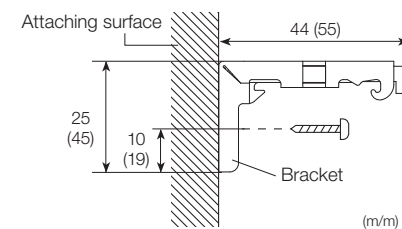
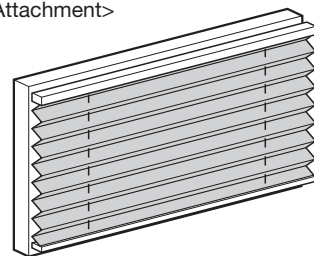

### <Ceiling Attachment>

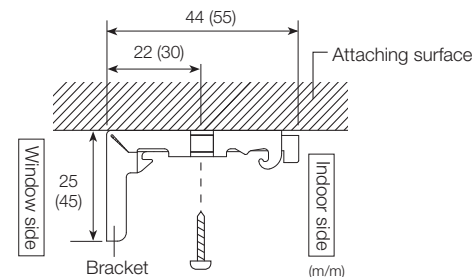
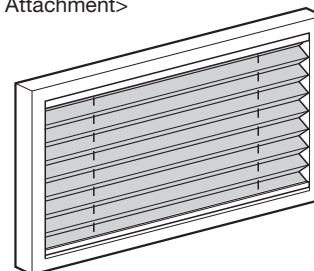

\* For Drum Type

## Bracket Position

- Install the Bracket in a position 40-70mm from the edges of the Head Rail.
- If there are three or more brackets, be sure to install them at intervals that are as equally spaced as possible.

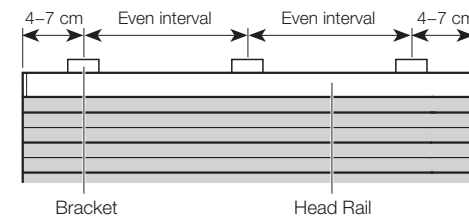

## Bracket installation

- Follow the above illustrations for "Installation Method" and use the included Fixing Screws to install the brackets.
- \* There is one Fixing Screw for each bracket. The above illustration is a dimensional drawing for the center of the elongated holes on the brackets. The brackets also have round holes, please use them according to installation conditions.

## ■ Installing the main unit

- 1 With the screen in the stacked position, latch the temporary stopper hook onto the front groove of the Head Rail.
- 2 Push the Head Rail in until it clicks into place.

### <Cord Type>

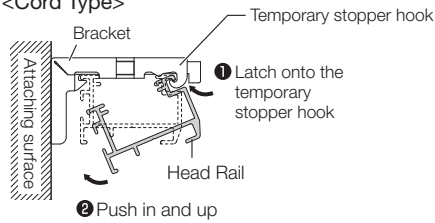

### <Drum Type>

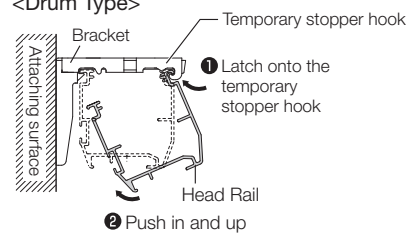

## ⚠ Caution

- ! After installing the main unit, make sure the main unit is secured to the brackets.

## ■ Uninstalling the main unit

- 1 With the screen in the stacked position, grasp the main unit and hold the Bracket release button while pulling forward.
- 2 Remove the main unit from the temporary stopper hook.

### <Cord Type>

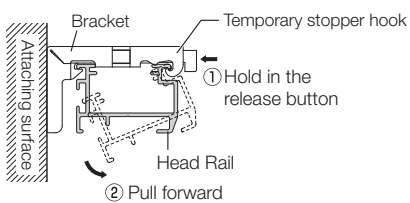

### <Drum Type>

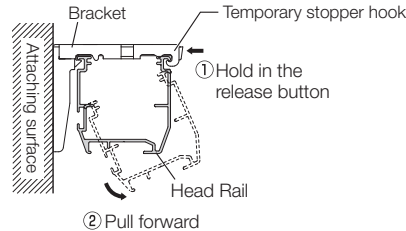

## ⚠ Caution

- ! When removing the product from the brackets, be sure to support it with your hand.

## ■ About the Safety Tassel

- This Safety Tassel is a part for preventing unexpected accidents such as the Operation Cord becoming wrapped around the neck or body of a child.
- Attach the Safety Tassel to the Operation Cord using the included ring and tie the Operation Cord in a place where children cannot reach.

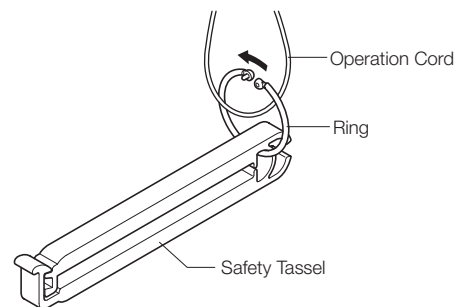

## Operation Methods

### <Cord Type>

- \* The changing movement for the Bottom Rail is composed of alternating stop and release movement.

## ⚠ Caution

- ! Before releasing your hand from the Operation Cord, make sure that the screen is securely stopped (be sure that the changing movement is set to stop). If the changing movement is not set to stop, the screen may forcefully fall and cause injury or damage.

## ■ Pull up the Screen

- When the Bottom Rail is in the lowest position, pull the Cord Joint or the Operation Cord downwards until the screen is in the position you want and release your hand.
- When the Bottom Rail is partially raised, pull the Cord Joint or Operation Cord downwards slightly, temporarily release your hand and then again pull the Cord Joint or Operation Cord until the screen is in the position you want and release your hand.

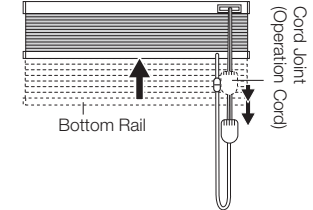
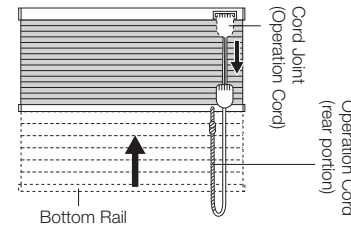

- \* When raising and lowering the Bottom Rail, do not pull on the rear portion of Operation Cord. Damage to the product will occur.

## ■ Pull down the Screen

- When the Cord Joint or Operation Cord is pulled downwards slightly, the stopper will be released and the screen will lower. If you want to stop the screen partway, again pull the Cord Joint or Operation Cord downwards and the stopper will engage, stopping the screen.

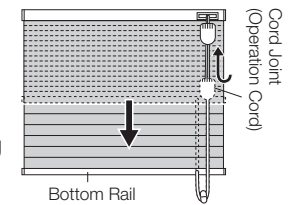

## ■ About the Safety Joint

## ⚠ Warning

- ⊘ Please do not allow children to play with the operation cord. Otherwise it may become wrapped around the neck or body and cause an unexpected accident.

- The Safety Joint is a part designed so that the Operation Cord will come apart in order to prevent danger in case of the Operation Cord becoming wrapped around a child's neck or body.

- If stress is placed on the Safety Joint or if the Operation Cord is operated by holding close to the Safety Joint, the Safety Joint will come apart. If it comes apart, do not attempt to use the Operation Cord. Re-assemble the Safety Joint before use.

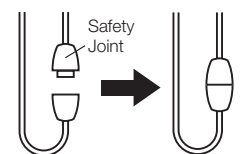

<Drum Type>

### ■ Pull up the screen

- Pull the front of the Drum Operation Cord ① downwards until the screen is in the position you want and release your hand.

### ■ Pull down the screen

- Pull the rear Drum Operation Cord ② downwards until the screen is in the position you want and release your hand.

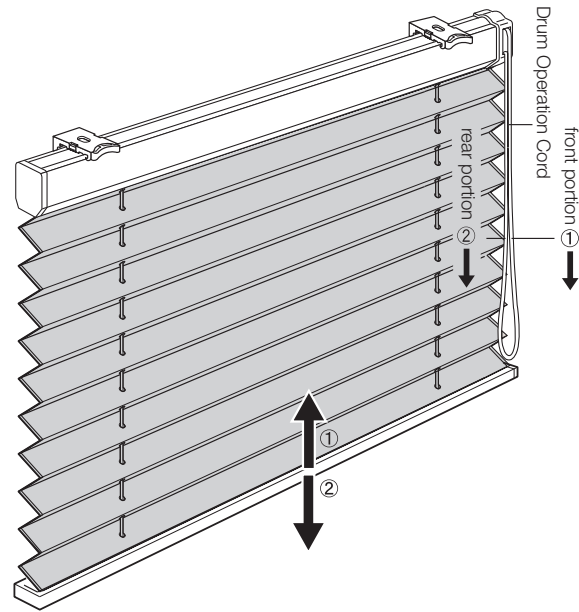

## Maintenance Sticker

- Your purchased product has an affixed maintenance sticker showing information related to the product. Please refer to this maintenance sticker when inquiring about the product or for repairs.

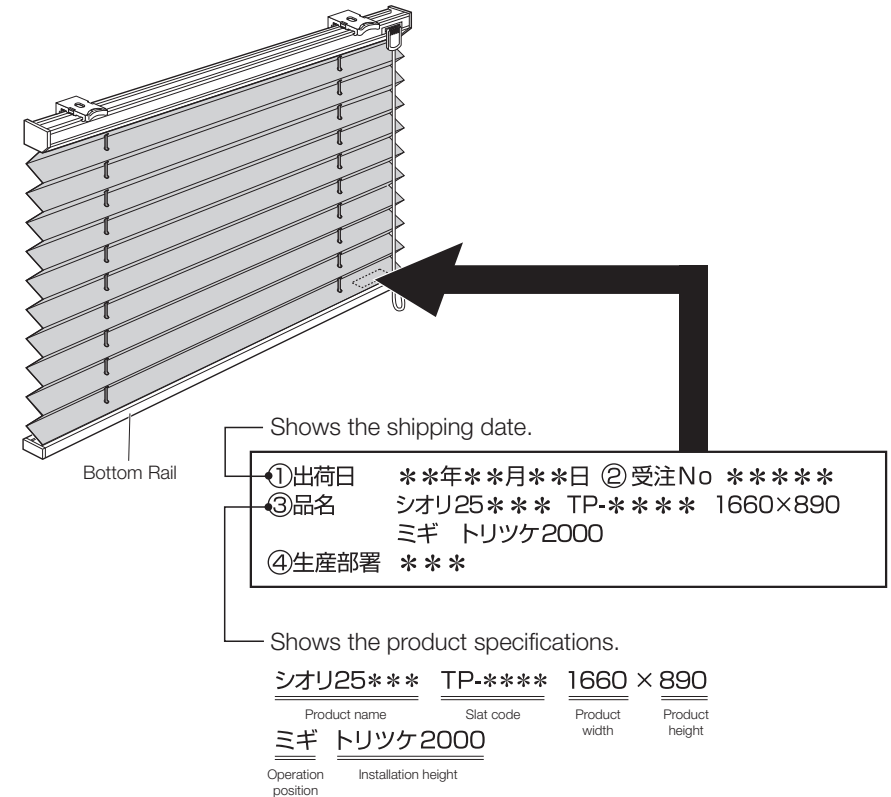

## Replacement screens

- “SHIORI Replacement Screens” are also sold so that the material can be replaced with the mechanisms left as-is. Perfect for redecorating or for replacing broken screens.
- ① There is a maintenance sticker on surface of the Bottom Rail in the Bottom right corner of the product.
- Please refer to this maintenance sticker
- ② when inquiring about the product or for repairs.

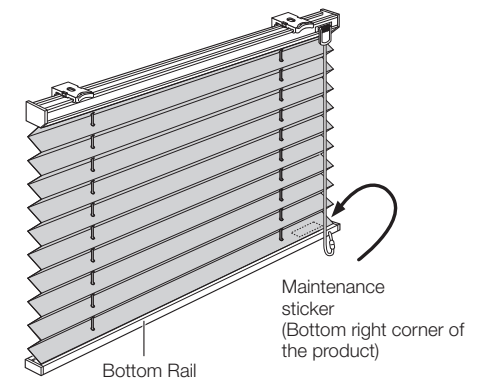

## Troubleshooting

### Example

Condition	Cause	Solution
<ul style="list-style-type: none"> <li>The screen won't lower. (Cord type)</li> </ul>	<p>➔ The Lift Cord may be twisted.</p>	<ul style="list-style-type: none"> <li>Untwist using the following procedure.</li> </ul>
<ul style="list-style-type: none"> <li>The screen won't stack neatly.</li> </ul>	<p>➔ The pleat folds may be disorganized.</p>	<ul style="list-style-type: none"> <li>See "Fixing screen folds that have become disorganized" on P.10 and P.11.</li> </ul>
<ul style="list-style-type: none"> <li>The screen raises diagonally.</li> </ul>	<p>➔ The pitch-keeper cord Bush securing position may be off.</p>	<ul style="list-style-type: none"> <li>See "Fixing screens that raise diagonally" on P.11.</li> </ul>

#### <Removing twists from the Lift Cord>

① Slide a screwdriver under the cover to remove it.

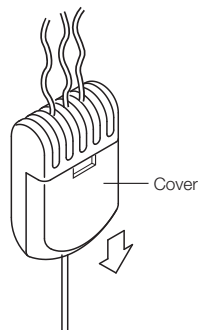

② Remove each twist from the Lift Cord and slide in the cover from the bottom.

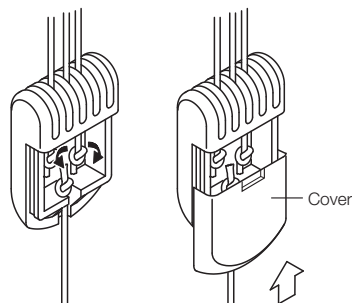

#### <Fixing screen folds that have become disorganized>

① If the screen is disorganized, adjust the pleats and raise into the stacked position.

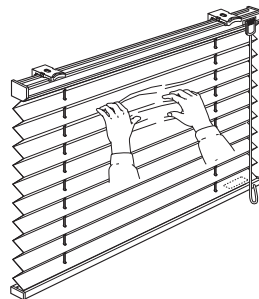

② Leave the screen in the stacked position for a while, and operate again once the pleat folds are corrected.

\* The length of time required for correction varies depending on the screen type and condition. If the screen disorganization is not corrected on the first attempt, leave the screen in the stacked position described in ② above for as long as possible.

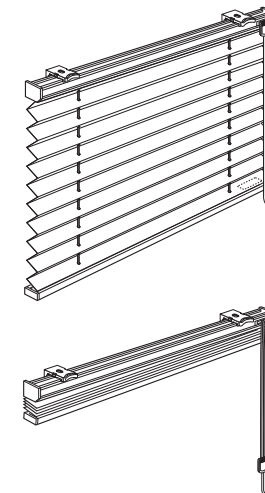

#### <Fixing screens that raise diagonally>

● The pitch-keeper cord Bush secured on the back of the Head Rail should be aligned directly above the Lift Cord.

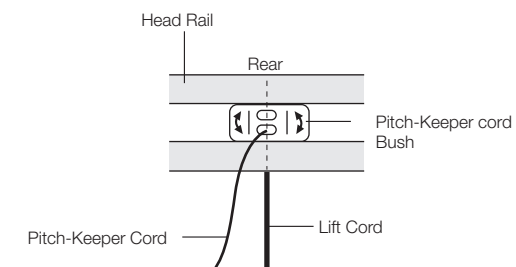

## Cleaning

- For regular care, dust with a feather duster or a hand mop.
- Refrain from wiping with water or the screen coming into contact with water as it may cause the colors to change.
- The screen has a special resin finish that may leave wrinkles or deformations if bent or folded. It may be impossible to return the screen to its original shape.